

Data sheet

Stainless steel-ball valve, Eco-Line very light, G 3/4", PN40

Item number:

VS4440-3/4



Example illustration

Item description

Materials:

Housing: 1.4408, ball: 1.4408, seal: PTFE, handle: 1.4301

Temperature range:

-20°C to +150°C

Operating range:

Water, oil, compressed air, fuels, solvents, aggressive media

Properties

G	G 3/4"
DN [mm]	20
L [mm]	65
PN [bar]	0 to 40
H [mm]	60
R [mm]	115

Further information:

Weight	340 g / pcs
GTIN	4050571903329
Customs duty number	84818081

Drawing:

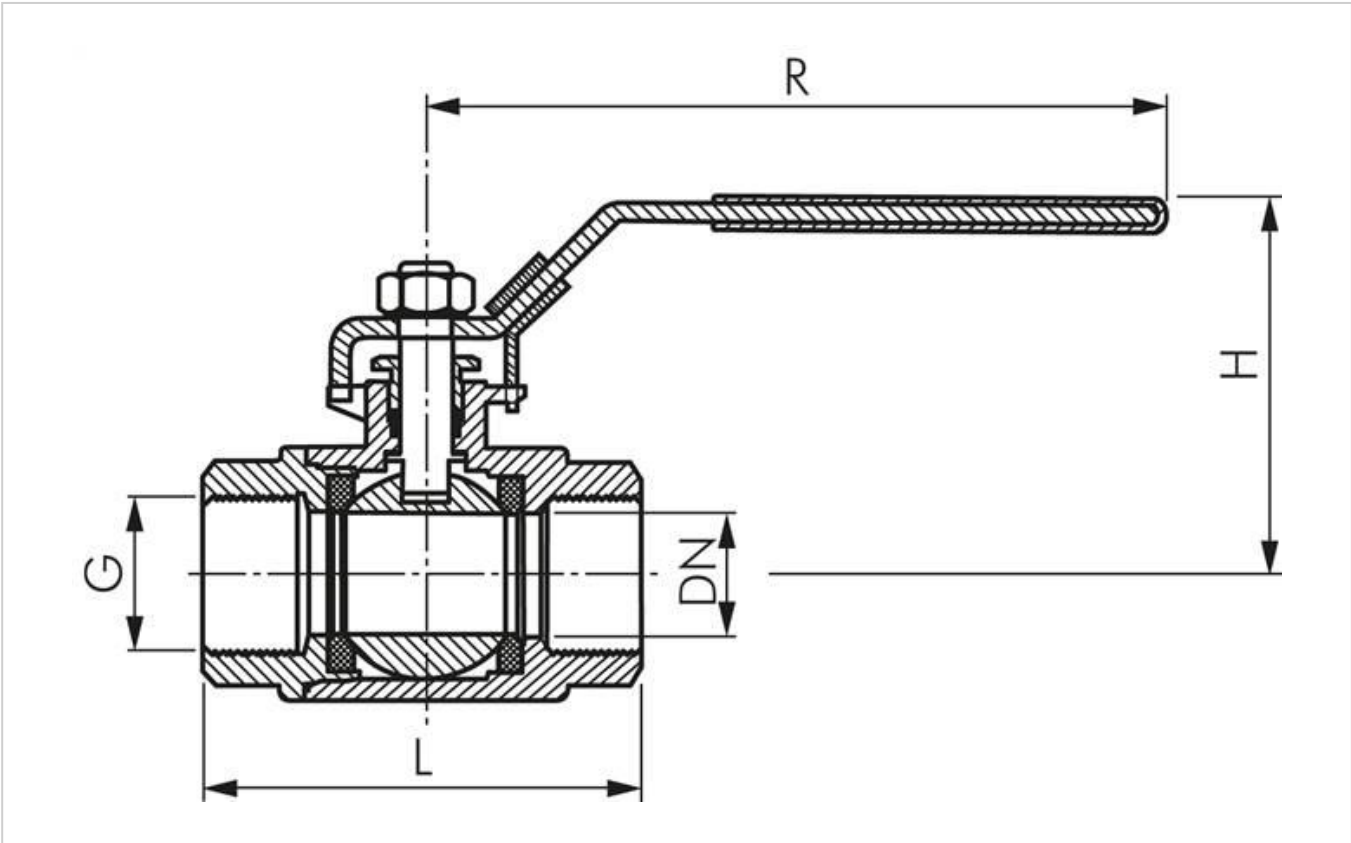

Drawing