

valvole ad azionamento elettropneumatico

solenoid actuated valves

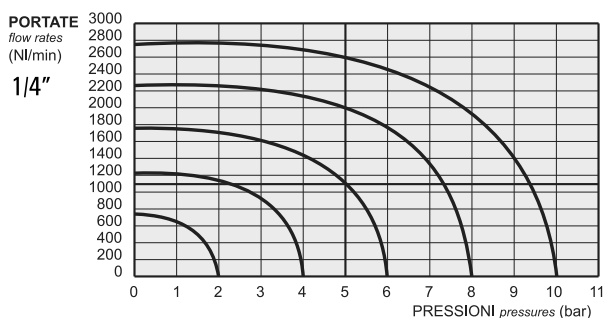

- Valvole a spola 3/2-5/2-5/3 con attacchi filettati G1/8"-G1/4"
3/2-5/2-5/3 spool valves with G1/8"-G1/4" threaded ports
- Montaggio in linea, su collettori multipli o su basi manifold
Installation in-line, on gang or modular manifolds
- Comandi elettrici con azionamento manuale bistabile
Solenoid pilots with detented manual override as standard
- A richiesta versione a basso assorbimento 1.5W
On request with low consumption 1.5W
- Esecuzioni speciali a richiesta
Special versions on request

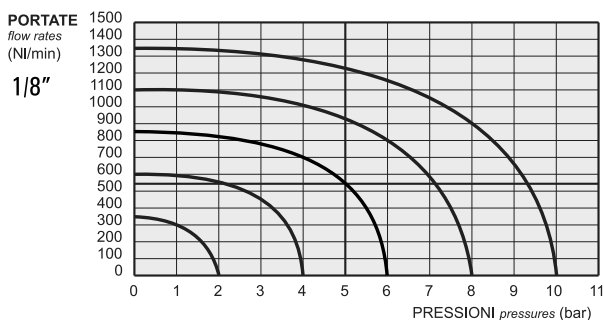

Materiali

Corpo: alluminio 11S

Comando e fondello: tecnopolimero (*)

Molle: INOX

Guarnizioni: NBR

Spola: alluminio nichelato

Parti interne: ottone OT58

Materials

Body: aluminium 11S

End caps: technopolymer (*)

Springs: stainless steel

Seals: NBR

Spool: nickel plated aluminium

Internal parts: brass OT58

(*) Su richiesta e dietro supplemento di prezzo, le valvole sono fornibili con corpo, comando e fondello interamente in alluminio. Alcune valvole, come di seguito specificato, sono disponibili solo nella versione in alluminio. Le valvole ATEX sono solo in alluminio.

Le parti in tecnopolimero recano impresso il logo

(*) On request and upon extra charge, the valves are available also with body and end caps entirely in aluminium. Some valves, as specified in the next pages, are available only in the aluminium version. ATEX valves are only in aluminium.

The parts in technopolymer are marked with the logo

Tempi di risposta - response times

	1/8"	1/4"
monostabile <i>mono-stable</i>	TRA (14): 15 ms TRR (12): 35 ms	TRA (14): 19 ms TRR (12): 45 ms
bistabile <i>bi-stable</i>	TRA (14): 20 ms TRR (12): 20 ms	TRA (14): 22 ms TRR (12): 22 ms

I prodotti di seguito indicati sono venduti senza bobine, da acquistarsi separatamente (vedi pag. 209).
The following listed products are sold without coils, which are bought separately (refer to page 209).

Diametro nominale <i>Nominal orifice</i>	1/8": 5 mm 1/4": 7.5 mm		
Temperatura di esercizio <i>Temperature range</i>	max +60°C		
Pressione di esercizio <i>Working pressure</i>	al. interna monost. [monost. internal air supply]	al. interna bist. [bi-stable internal air supply]	alim. separata [separate air supply]
	2.5 ... 10 bar 0.25 ... 1 MPa	1 ... 10 bar 0.1 ... 1 MPa	-0.9 ... 10 bar -0.09 ... 1 MPa
Pressione di azionamento (per alimentazione separata) <i>Actuating pressure (for separate air supply)</i>	monostabile [mono-stable]		bistabile [bi-stable]
	2.5 ... 10 bar 0.25 ... 1 MPa		1 ... 10 bar 0.1 ... 1 MPa
Fluido <i>Fluid</i>	Aria filtrata 50µ con o senza lubrificazione <i>50µ filtered, lubricated or non lubricated air</i>		

valvole ad azionamento elettropneumatico

solenoid actuated valves



322 EFP

3/2 1/4" NC comando elettrico - ritorno a molla pneumatica

3/2 1/4" NC solenoid pilot - pneumatic spring return

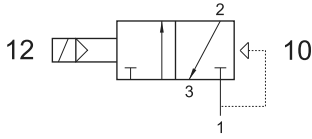

Non può essere utilizzata come valvola normalmente aperta.
It cannot be used as normally open valve.

SOLO VERSIONE IN ALLUMINIO
ONLY ALUMINIUM VERSION

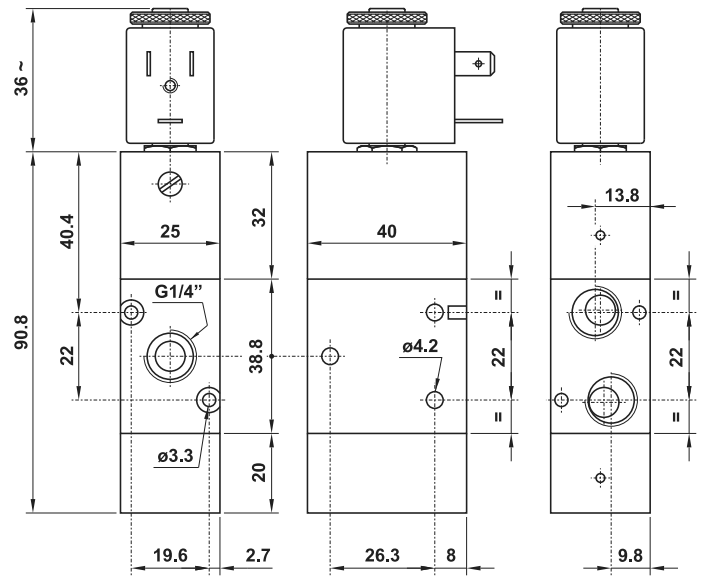

522 EE

5/2 1/4" doppio comando elettrico

5/2 1/4" double solenoid pilot

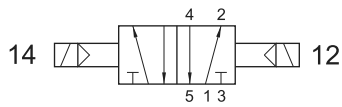

SOLO VERSIONE IN ALLUMINIO
ONLY ALUMINIUM VERSION

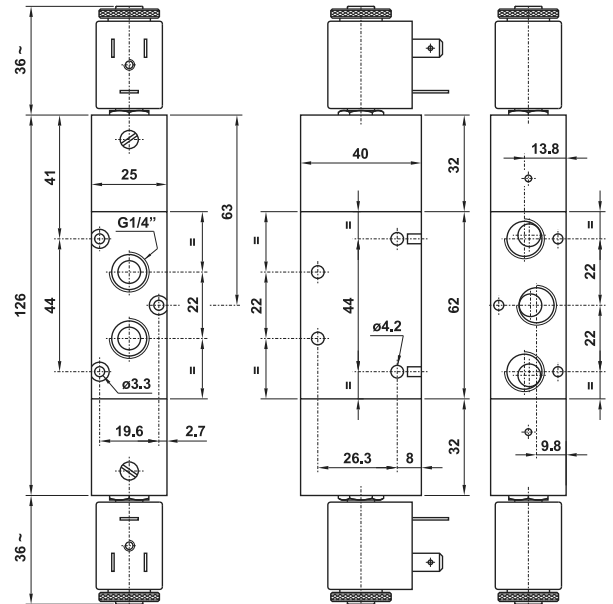

522 EED

5/2 1/4" doppio comando elettrico - con differenziale

5/2 1/4" double solenoid pilot - with differential

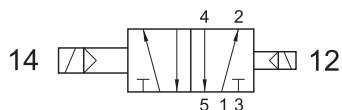

SOLO VERSIONE IN ALLUMINIO
ONLY ALUMINIUM VERSION

